

SITRANS F flowmeters

SITRANS F US

Flowmeter SITRANS FUS380 standard

Overview



The 2-track flowmeter SITRANS FUS380 comes as battery or mains-powered and is designed to measure water flow in district heating plants, local networks, boiler stations, substations, chiller plants and other general water applications.

The type-approved flowmeter version is named SITRANS FUE380 - see page 4/230.

Technically, the meter types SITRANS FUS380 and SITRANS FUE380 are completely identical, only difference is the calibration limit and the type approval for custody transfer.

Benefits

- Battery-powered up to 6 years
- 115/230 V mains-powered with back-up battery option in case of mains power failure
- Fast measuring frequency 20 Hz/0.5 Hz (230 V AC/Battery)
- Easy one-button straight forward display
- 2-track measuring principle for optimum accuracy
- Compact or remote mounting
- Measures on all district water qualities and water conductivities
- No pressure drop
- Long-term stability
- 2 galvanically isolated digital outputs for easy connection to a calculator (potential-free)
- Bidirectional measurement, with 2 totalizers and outputs
- Dynamic range $Q_{\min}:Q_{\max}$ up to 1:400
- MODBUS RTU/RS 232, RS 485

Application

The main application for SITRANS FUS380 is measurement of water flow or water flow in heat meter systems in district heating networks or chilled water.

Design

The 2-track design of SITRANS FUS380 ensures maximum accuracy under short inlet conditions. The flowmeter consists of a flow sensor pipe, 4 transducers/transducer cables and a transmitter SITRANS FUS080.

The unit is available in a compact or a remote version with up to 30 meter distance from flowmeter to transmitter. When ordering a compact version the transducer cables are pre-mounted and ready for installation.

Compact mounting is only possible up to 120 °C (248 °F). The sensor must be isolated to protect transmitter from heat. The transmitter is available in an IP67/NEMA 4X/6 enclosure.

Integration

The flowmeter digital output is often used as input for an energy meter or as input for digital systems for remote reading.

SITRANS FUS380 has two digital output functions that can be individually selected, and optional MODBUS RTU communication modules.

Pulse output rate is defined when ordering.

If the flowmeter forms part of an energy meter system for custody transfer, no further approvals are needed, except possible local approvals on the flowmeter.

Configuration SITRANS FUS380

Selection guide SITRANS FUS380, standard version

DN	Q _s (m ³ /h)	Q _{max} (m ³ /h) (105% of Q _s)	Q _p (m ³ /h)	Q _i (m ³ /h) (1:100 of Q _p)	Cut-off (m ³ /h) (50% of Q _i)	Cut-off (% of Q _{max})	Typical pulse value ¹⁾ (l/pulse)
50	15	15.75	15	0.15	0.075	0.48	1
50	45	47.25	15	0.15	0.075	0.16	1
50	45	47.25	30	0.3	0.150	0.32	1
65	25	26.25	25	0.25	0.125	0.48	1
65	72	75.6	25	0.25	0.125	0.17	1
65	72	75.6	50	0.5	0.250	0.33	1
80	40	42	40	0.4	0.200	0.48	2.5
80	120	126	40	0.4	0.200	0.16	2.5
80	120	126	80	0.8	0.400	0.32	2.5
100	60	63	60	0.6	0.300	0.48	2.5
100	180	189	60	0.6	0.300	0.16	2.5
100	240	252	120	1.2	0.600	0.24	2.5
125	10	10.5	100	1	0.500	4.76	2.5
125	280	294	100	1	0.500	0.17	2.5
125	400	420	200	2	1.000	0.24	2.5
150	150	157.5	150	1.5	0.750	0.48	10
150	420	441	150	1.5	0.750	0.17	10
150	560	588	300	3	1.500	0.26	10
200	250	262.5	250	2.5	1.250	0.48	10
200	700	735	250	2.5	1.250	0.17	10
200	900	945	500	5	2.500	0.26	10
250	400	420	400	4	2.000	0.48	10
250	1120	1176	400	4	2.000	0.17	10
250	1400	1470	800	8	4.000	0.27	10
300	560	588	560	5.6	2.800	0.48	50
300	1560	1638	560	5.6	2.800	0.17	50
300	2100	2205	1120	11.2	5.600	0.25	50
350	750	787.5	750	7.5	3.750	0.48	50
350	2100	2205	750	7.5	3.750	0.17	50
350	2800	2940	1500	15	7.500	0.26	50
400	950	997.5	950	9.5	4.750	0.48	50
400	2660	2793	950	9.5	4.750	0.17	50
400	3600	3780	1900	19	9.500	0.25	50
500	1475	1548.75	1475	14.75	7.375	0.48	100
500	4130	4336.5	1475	14.75	7.375	0.17	100
500	5500	5775	2950	29.5	14.750	0.26	100
600	2150	2257.5	2150	21.5	10.750	0.48	100
600	6020	6321	2150	21.5	10.750	0.17	100
600	8000	8400	4300	43	21.500	0.26	100
700	2900	3045	2900	29	14.500	0.48	100
700	8120	8526	2900	29	14.500	0.17	100
700	10 800	11 340	5800	58	29.000	0.26	100
800	3800	3990	3800	38	19.000	0.48	100
800	10 640	11 172	3800	38	19.000	0.17	100
800	14 200	14 910	7600	76	38.000	0.25	100
900	5000	5250	3800	38	19.000	0.36	100
900	14 000	14 700	5000	50	25.000	0.17	100
900	20 000	21 000	5000	50	25.000	0.12	100
1000	6000	6300	3800	38	19.000	0.30	100

SITRANS F flowmeters

SITRANS F US

Flowmeter SITRANS FUS380 standard

DN	Q _s (m ³ /h)	Q _{max} (m ³ /h) (105% of Q _s)	Q _p (m ³ /h)	Q _i (m ³ /h) (1:100 of Q _p)	Cut-off (m ³ /h) (50% of Q _i)	Cut-off (% of Q _{max})	Typical pulse value ¹⁾ (l/pulse)
1000	16 800	17 640	6000	60	30.000	0.17	100
1000	24 000	25 200	12 000	120	60.000	0.24	100
1200	9000	9450	3800	38	19.000	0.20	100
1200	25 200	26 460	9000	90	45.000	0.17	100
1200	36 000	37 800	18 000	180	90.000	0.24	100

The values Q_i, Q_p and Q_s are shown on the system label of the FUS380. Q_i (Q_{min}) means the minimal and Q_p (Q_{nom}) the nominal flow rate. Q_s is the highest operatable flow rate. The maximum flow rate (Q_{max}) is 105% of Q_s. The low flow cut-off is 50 % of Q_i.

In order to obtain best pulse output resolution in the range Q_{min} to Q_s of approx. 100 Hz at Q_s, two or three flow values for every dimension can be selected at ordering. Therefore the ordering data table also shows Q_p (Q_n). This flow rate is between Q_i (Q_{min}) and Q_s and indicates the normal or typical flow.

¹⁾ Typical pulse values for SITRANS FUS380. Other pulse values are possible - see Selection and Ordering data table.

4

Technical specifications

Pipe design	2-track sensor with flanges and integrated transducers wet-calibrated from factory
Nominal size welded version	DN 50, 65, 80, 100, 125, 150, 200, 250, 300, 350, 400, 500, 600, 700, 800, 900, 1000, 1200
Pressure rate	PN 16, PN 25, PN 40 EN 1092-1
Pipe material	<ul style="list-style-type: none"> DN 100 ... DN 1200: Carbon Steel EN 1.0345 / p235 GH, painted in light-gray. DN 50 ... 80: Die-cast bronze G-CuSn10/W2.1050.01 (EN1982)
Transducer design	<ul style="list-style-type: none"> DN 100 ... DN 1200: Integrated version and welded onto the pipe DN 50 ... DN 80: Screwed into the pipe
Transducer material	Stainless steel (AISI 316/1.4404)/brass (CuZn36Pb2as)

Sensor operating conditions

Storage	-40 ... +85 °C (-40 ... +185 °F)
Media/surface temperature	DN 100 ... DN 1200: <ul style="list-style-type: none"> Remote: 2 ... 200 °C (35.6 ... 392 °F) DN 50 ... DN 80: <ul style="list-style-type: none"> Remote: 2 ... 150 °C (35.6 ... 302 °F) DN 50 ... DN 1200: <ul style="list-style-type: none"> Compact: 2 ... 120 °C (35.6 ... 248 °F)
Degree of protection	Sensor connection IP67/NEMA 4X/6
Max. flow velocity	DN 50 ... DN 1200: 9 m/s (29.5 ft/s)
Electromagnetic compatibility	
• Emitted interference	To EN 61000-6-4
• Noise immunity	To EN 61000-6-2

Transmitter

The transmitter related to this system is the SITRANS FUS080. Technical specifications to the FUS080 see page 4/194 ff.

Sensor cable

Cable length	Max. 30 m (98.4 ft) between transmitter and sensor
--------------	--

Certificates and approvals

Conformity certificate	The devices are supplied as standard with a Siemens Certificate of Conformity on CD
Material certificate	Material certificate according EN 10204-3.1 is optionally available
Calibration report	A standard calibration report is shipped with every flowmeter. Extended accredited ISO/IEC 17025 calibration certificates optionally available
Approvals	No custody transfer approvals

SITRANS FUS380 uncertainty

	FUS380
Flow value setting	Predefined settings according to dimension
Approval	No approval
Flow rate v_f	0.02 ... 9 m/s (0.065 ... 29.5 ft/s)
Output A	Pulse: forward, reverse, forward net, reverse net (Preset: forward)
Output B	Pulse (forward, reverse, forward net, reverse net, alarm, call-up (Preset: alarm)
Pulse value A & B (depending on DN value)	0.1 l/p, 0.25 l/p, 0.5 l/p, 1 l/p, 2.5 l/p, 10 l/p, 25 l/p, 50 l/p, 100 l/p, 250 l/p, 500 l/p, 1 m ³ /p, 2.5 m ³ /p, 5 m ³ /p, 10 m ³ /p, 25 m ³ /p, 50 m ³ /p, 100 m ³ /p, 250 m ³ /p, 500 m ³ /p, 1000 m ³ /p
Pulse width	5/10/20/50/100/200/500 ms
Flow unit setup	Preset: m ³ /h
Volume unit setup	Preset: m ³

To ensure continuous accurate measurement, flowmeters must be calibrated. The calibration is conducted at SIEMENS flow facilities accredited according to ISO/IEC 17025 by DANAK or UKAS.

The accreditation bodies DANAK and UKAS have signed the ILAC MRA agreement (International Laboratory Accreditation Corporation - Mutual Recognition Arrangement). Therefore the accreditation ensures international traceability and recognition of the test results in 39 countries worldwide, including the US (NIST traceability).

A standard calibration certificate with Q_n as selected flow is shipped with each SITRANS FUS380. This production calibration protocol consists of 2 x 3 points at Q_i , 10% Q_p and Q_p (max. 4 200 m³/h).

Accuracy SITRANS FUS380:

Standard calibration: Better than 0.5% of rate, 0.5 m/s < v < 8 m/s
 $v < 0.5$ m/s, $0.5 + 0.25/v$ [%]

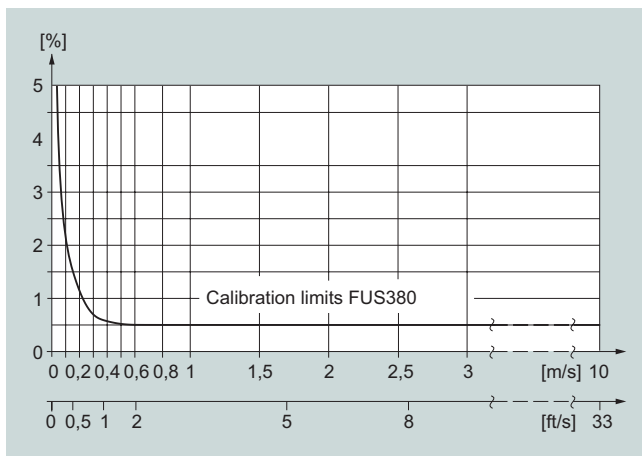

SITRANS F flowmeters

SITRANS F US

Flowmeter SITRANS FUS380 standard

Selection and Ordering data

Flowmeter SITRANS FUS380 (standard) Order No. Order code
 7ME3400- 0 - A

Diameter	Flow setting [m ³ /h]		
	Q _p (Q _n) ¹⁾	Q _s	
DN 50 (2") ²⁾	15	15	1 A
DN 50 (2") ²⁾	15	45	1 C
DN 50 (2") ²⁾	30	45	1 D
DN 65 (2½") ²⁾	25	25	1 E
DN 65 (2½") ²⁾	25	72	1 G
DN 65 (2½") ²⁾	50	72	1 H
DN 80 (3") ²⁾	40	40	1 J
DN 80 (3") ²⁾	40	120	1 L
DN 80 (3") ²⁾	80	120	1 M
DN 100 (4")	60	60	1 N
DN 100 (4")	60	180	1 Q
DN 100 (4")	120	240	1 R
DN 125 (5")	100	100	1 S
DN 125 (5")	100	280	1 U
DN 125 (5")	200	400	1 V
DN 150 (6")	150	150	2 A
DN 150 (6")	150	420	2 C
DN 150 (6")	300	560	2 D
DN 200 (8")	250	250	2 E
DN 200 (8")	250	700	2 G
DN 200 (8")	500	900	2 H
DN 250 (10")	400	400	2 J
DN 250 (10")	400	1120	2 L
DN 250 (10")	800	1400	2 M
DN 300 (12")	560	560	2 N
DN 300 (12")	560	1560	2 Q
DN 300 (12")	1120	2100	2 R
DN 350 (14")	750	750	2 S
DN 350 (14")	750	2100	2 U
DN 350 (14")	1500	2800	2 V
DN 400 (16")	950	950	3 A
DN 400 (16")	950	2660	3 C
DN 400 (16")	1900	3600	3 D
DN 500 (20")	1475	1475	3 J
DN 500 (20")	1475	4130	3 L
DN 500 (20")	2950	5500	3 M
DN 600 (24")	2150	2150	3 S
DN 600 (24")	2150	6020	3 U
DN 600 (24")	4300	8000	3 V
DN 700 (28")	2900	2900	4 E
DN 700 (28")	2900	8120	4 G
DN 700 (28")	5800	10 800	4 H
DN 800 (32")	3800	3800	4 N
DN 800 (32")	3800	10 640	4 Q
DN 800 (32")	7600	14 200	4 R
DN 900 (36")	5000	5000	5 A
DN 900 (36")	5000	14 000	5 C
DN 900 (36")	10000	20 000	5 D
DN 1000 (40")	6000	6000	5 J
DN 1000 (40")	6000	16 800	5 L
DN 1000 (40")	12 000	24 000	5 M
DN 1200 (48")	9000	9000	5 S
DN 1200 (48")	9000	25 200	5 U
DN 1200 (48")	18 000	36 000	5 V

This device is shipped with a Quick Start guide and the SITRANS F manual CD containing the complete manual library. Printed Operating Instructions are available for purchase via PMD.

Selection and Ordering data

Flowmeter SITRANS FUS380 (standard) Order No. Order code
 7ME3400- 0 - A

Flange norm and pressure rating		
System without sensor - only a transmitter FUS080 as spare part - settings as defined with this order no.	A	
EN 1092-1 Flanges		
PN 16 (DN 100 ... DN 1200)	C	
PN 25 (DN 200 ... DN 1000)	D	
PN 40 (DN 50 ... DN 250) ³⁾	E	
Compact / remote connection		
Compact version, max. 120 °C (248 °F) up to DN 800	0	
Remote version, max. 150/200 °C (302/392 °F)		
5 m (16.4 ft)	2	
10 m (32.8 ft)	3	
20 m (65.6 ft)	4	
30 m (98.4 ft)	5	
Pulse output value setup		
0.1 l/p (option for DN 50 ... DN 65) with 5 ms	1	
1 l/p (typical for DN 50 ... DN 65) with 5 ms	2	
2.5 l/p (typical for DN 80 ... DN 125) with 5 ms	3	
10 l/p (typical for DN 150 ... DN 250) with 5 ms	4	
50 l/p (typical for DN 300 ... DN 400) with 5 ms	5	
100 l/p (typical for DN 500 ... DN 1200) with 5 ms	6	
250 l/pulse	7	
1 m ³ /pulse	8	
0.25 l/pulse	9	NOA
0.5 l/pulse	9	NOB
5 l/pulse	9	NOC
25 l/pulse	9	NO D
500 l/pulse	9	NO E
2.5 m ³ /pulse	9	NO F
5 m ³ /pulse	9	NO G
10 m ³ /pulse	9	NO H
25 m ³ /pulse	9	NO J
50 m ³ /pulse	9	NO K
100 m ³ /pulse	9	NO L
250 m ³ /pulse	9	NO M
500 m ³ /pulse	9	NO N
1000 m ³ /pulse	9	NO P
Transmitter SITRANS FUS080		
IP67/NEMA 4X/6 115 ... 230 V AC	B	
IP67/NEMA 4X/6 3.6 V battery version, incl. dual battery pack	D	
IP67/NEMA 4X/6 115 ... 230 V AC, including 3.6 V single battery backup	E	
IP67/NEMA 4X/6 3.6 V battery version (no battery pack included) ⁴⁾	G	
Pulse width setup		
5 ms (standard)	2	
10 ms	3	
20 ms	4	
50 ms	5	
100 ms	6	
200 ms	7	
500 ms	8	

1) Q_p (Q_n) is the normal or typical flow. Q_p and Q_s is shown on the system label.
 2) Pipe material bronze brass.
 3) PN 40 standard for DN 50 ... DN 80 die-cast bronze pipes.
 4) Lithium batteries are subject to special transportation regulations according to United Nations "Regulation of Dangerous Goods, UN 3090 and UN 3091". Special transport documentation is required to observe these regulations. This may influence both transport time and costs.

Selection and Ordering data	Order code
Additional information	
Please add „-Z“ to Order No. and following add-on code(s) with plain text.	
Calibration / certificate FUS380	
Production calibration for DN 50 ... DN 1200 with Q_n as selected in diameter Calibration protocol: 2 x 3 points, Q_i , 10% Q_p and Q_p (max. 4200 m ³ /h).	Included
Accredited Siemens ISO/IEC 17025 calibration for DN 50 ... DN 200 with Q_n as selected in diameter. Certificate: 2 x 3 points, Q_i , 10% Q_p and Q_p (max. 250 m ³ /h).	D20
Accredited Siemens ISO/IEC 17025 calibration for DN 100 ... DN 500 with Q_n as selected in diameter. Certificate: 2 x 3 points, Q_i , 10% Q_p and Q_p (max. 1300 m ³ /h).	D21
Accredited Siemens ISO/IEC 17025 calibration, DN 300 ... DN 1200 with Q_n as selected in diameter. Certificate: 2 x 3 points, Q_i , 10% Q_p and Q_p (max. 4200 m ³ /h).	D22
Output B as reverse flow pulses. No calibration/verification.	E21
Material certificate	
EN 10204-3.1	F10
Tag name plate	
Stainless steel tag name plate, text length depends on font size: 8 mm up to 10 characters, 4 mm up to 20 characters, or 3 mm up to 30 characters (add plain text)	Y17
For accessories and spare parts see end of following chapter on FUE380.	

MLFB Ordering example

Customer requires a flowmeter:

- DN 250, PN 25, compact version (media temperature max. 120 °C (248 °F)), mains power version.
- Material certificate and metal tag name plate.
- Pulse output for for 10 l/pulse and min. 5 ms pulse width.

Ordering:

FUS380: **7ME3400-2LD00-4BA2-Z, F10, Y17**



Please use online Product selector to get latest updates. Product selector link:

www.pia-selector.automation.siemens.com











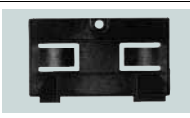

SITRANS F flowmeters

SITRANS F US

Flowmeter FUS380 and FUE380

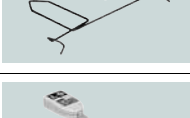
Accessories and spare parts for flowmeter FUS380 and FUE380

SITRANS FUS380/FUE380 - Spare parts

Type/description	Order No.	
Dual battery pack (6 year life-time) 33 Ah ¹⁾	FDK:087H2255	
Single battery back-up to main supply 13.5 Ah. Attention on note 1)	FDK:087L4201	
Battery cover for transmitter FUS080	A5E00694468	
PG 13.5 set (2 pcs.) for main cable/pulse cable	FDK:083G0228	
PG 13.5 set (2 pcs.) for dual coax cable (6 mm)	A5E00694500	
SITRANS FUS/FUE380 wall mounting kit for remote transmitter mounting, including connection plate (DN 50 ... DN 1200/2" ... 48")	A5E00694509	
SITRANS FUS/FUE380 terminal box for compact transmitter mounting, including connection plate, (bronze sensors only, DN 50 ... DN 80/2" ... 3")	A5E01208138^{F)}	
SITRANS FUS/FUE380 terminal box for compact transmitter mounting, including connection plate, (steel sensors only, DN 100 ... DN 1200/4" ... 48")	A5E00694660^{F)}	
Brace (holder) for optical IrDA eye	A5E00695277	
IrDA infrared interface adapter with USB for data acquisition with 1.2 m (3.9 ft) cable	FDK:087L4163	
RS 232 add-on module, point to point communication interface with MODBUS RTU protocol	FDK:087L4212	
RS 485 add-on module, multi-drop communication interface with MODBUS RTU protocol	FDK:087L4213	

Type/description	Order No.	
5 m (16.4 ft) cable set (4 pcs.) for DN 50 ... DN 80 (2" ... 3") remote mounting	A5E01208092^{F)}	
10 m (32.8 ft) cable set (4 pcs.) for DN 50 ... DN 80 (2" ... 3") remote mounting	A5E01208114^{F)}	
20 m (65.6 ft) cable set (4 pcs.) for DN 50 ... DN 80 (2" ... 3") remote mounting	A5E01208117^{F)}	
30 m (98.4 ft) cable set (4 pcs.) for DN 50 ... DN 80 (2" ... 3") remote mounting	A5E01208121^{F)}	
1 m (3.28 ft) cable set (4 pcs.) for DN 50 ... DN 80 (2" ... 3") for compact version	A5E01208126^{F)}	
5 m (16.4 ft) cable set (4 pcs.) for DN 100 ... DN 1200 (4" ... 48") remote mounting	A5E00695476^{F)}	
10 m (32.8 ft) cable set (4 pcs.) for DN 100 ... DN 1200 (4" ... 48") remote mounting	A5E00695479^{F)}	
20 m (65.6 ft) cable set (4 pcs.) for DN 100 ... DN 1200 (4" ... 48") remote mounting	A5E00695480^{F)}	
30 m (98.4 ft) cable set (4 pcs.) for DN 100 ... DN 1200 (4" ... 48") remote mounting	A5E00695483^{F)}	
1 m (3.28 ft) cable set (4 pcs.) for DN 100 ... DN 1200 (4" ... 48") for compact version	A5E00695486^{F)}	

Process Device Manager SIMATIC PDM

SIMATIC PDM Single Point V6.0

6ES7658-3HX06-0YA5

For operation and parameterization of one field device, communication using PROFIBUS DP/PA or HART modem, incl. 1 TAG
Cannot be expanded by further functions or TAG option/power-pack 5 languages (German, English, French, Spanish, Italian) executes with Windows 2000 Professional or Windows XP Professional

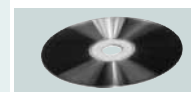

¹⁾ Lithium batteries are subject to special transportation regulations according to United Nations "Regulation of Dangerous Goods, UN 3090 and UN 3091". Special transport documentation is required to observe these regulations. This may influence both transport time and costs.
^{F)} Subject to export regulations AL: 91999, ECCN: N.

Downloads for DEVICE description FUE380
<http://support.automation.siemens.com/WWW/view/en/17320235>

Dimensional drawings

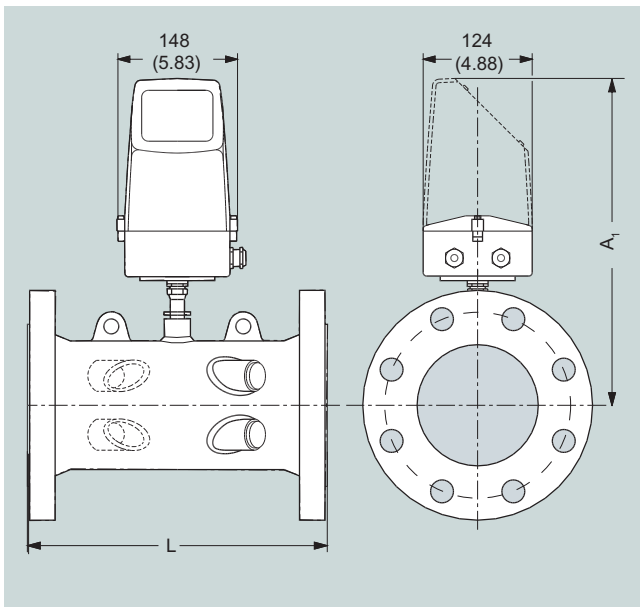

Transmitter IP67/NEMA 4X/6, wall mounting

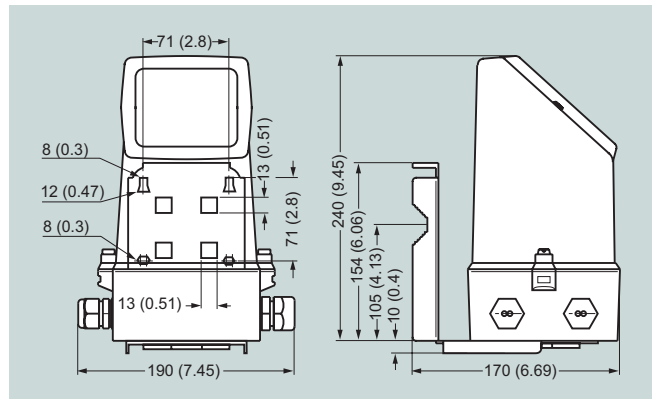

Pipe Dimensions for FUS380 and FUE380

Size	PN 16		PN 25		PN 40		A1	Lift hug
	L	Weight	L	Weight	L	Weight		
DN	mm	kg	mm	kg	mm	kg	mm	
50	-	-	-	-	300 +0/-2	10	350	No
65	-	-	-	-	300 +0/-2	15	360	No
80	-	-	-	-	350 +0/-3	18	370	No
100	350 +0/-2	15	-	-	350 +0/-3	18	375	No
125	350 +0/-2	18	-	-	350 +0/-3	24	380	No
150	500 +0/-3	28	-	-	500 +0/-3	34	390	No
200	500 +0/-3	38	500 +0/-3	47	500 +0/-3	55	414	No
250	600 +0/-3	60	600 +0/-3	76	600 +0/-3	91	440	No
300	500 +0/-3	66	500 +0/-3	81	-	-	466	Yes
350	550 +0/-3	94	550 +0/-3	121	-	-	495	Yes
400	600 +0/-3	124	600 +0/-3	153	-	-	507	Yes
500	625 +0/-3	176	625 +0/-3	235	-	-	558	Yes
600	750 +0/-3	244	750 +0/-3	292	-	-	609	Yes
700	875 +0/-3	258	875 +0/-3	416	-	-	660	Yes
800	1000 +0/-3	338	1000 +0/-3	562	-	-	710	Yes
900	1230 +6/-6	475	1300 +6/-6	835	-	-	810	No
1000	1300 +6/-6	594	1370 +6/-6	1078	-	-	910	No
1200	1360 +6/-6	860	-	-	-	-	1110	No

Notes:

- Weight for transmitter/electronics 1.5 kg (3.3 lb)
- - Means not available
- All weights are **approximately**
- For flange values - see norm EN 1092-1

SITRANS F flowmeters

SITRANS F US

Flowmeter FUS380 and FUE380

Size	PN 16		PN 25		PN 40		A1	Lift hug
	L	Weight	L	Weight	L	Weight		
inch	inch	lb	inch	lb	inch	lb	inch	
2	-	-	-	-	12 +0/-0.08	22	14	No
2½	-	-	-	-	12 +0/-0.08	33	14.4	No
3	-	-	-	-	14 +0/-0.08	40	14.8	No
4	13.77 +0/-0.08	33	-	-	13.77 +0/-0.12	40	15	No
5	13.77 +0/-0.08	40	-	-	13.77 +0/-0.12	53	15.2	No
6	19.68 +0/-0.12	62	-	-	19.68 +0/-0.12	75	15.6	Yes
8	19.68 +0/-0.12	84	19.68 +0/-0.12	104	19.68 +0/-0.12	121	16.30	Yes
10	23.62 +0/-0.12	132	23.62 +0/-0.12	168	23.62 +0/-0.12	201	17.32	Yes
12	19.68 +0/-0.12	146	19.68 +0/-0.12	179	-	-	18.35	Yes
14	21.65 +0/-0.12	207	21.65 +0/-0.12	267	-	-	19.8	Yes
16	23.62 +0/-0.12	273	23.62 +0/-0.12	337	-	-	19.96	Yes
20	24.61 +0/-0.12	419	24.61 +0/-0.12	538	-	-	21.97	Yes
24	29.53 +0/-0.12	668	29.53 +0/-0.12	805	-	-	23.98	Yes
28	34.45 +0/-0.12	796	34.45 +0/-0.12	1217	-	-	25.98	Yes
32	39.37 +0/-0.12	1089	39.37 +0/-0.12	1698	-	-	27.95	Yes
36	39.2 +0/-0.24	1047	52.00 +0/-0.24	1841	-	-	32.4	No
40	52 +0/-0.24	1310	54.80 +0/-0.24	2376	-	-	36.4	No
48	54.4 +0/-0.24	1892	-	-	-	-	44.4	No

Notes:

- Weight for transmitter/electronics 1.5 kg (3.3 lb)
- - Means not available
- All weights are **approximate**
- For flange values - see norm EN 1092-1

Schematics

Electrical connection FUS380 and FUE380

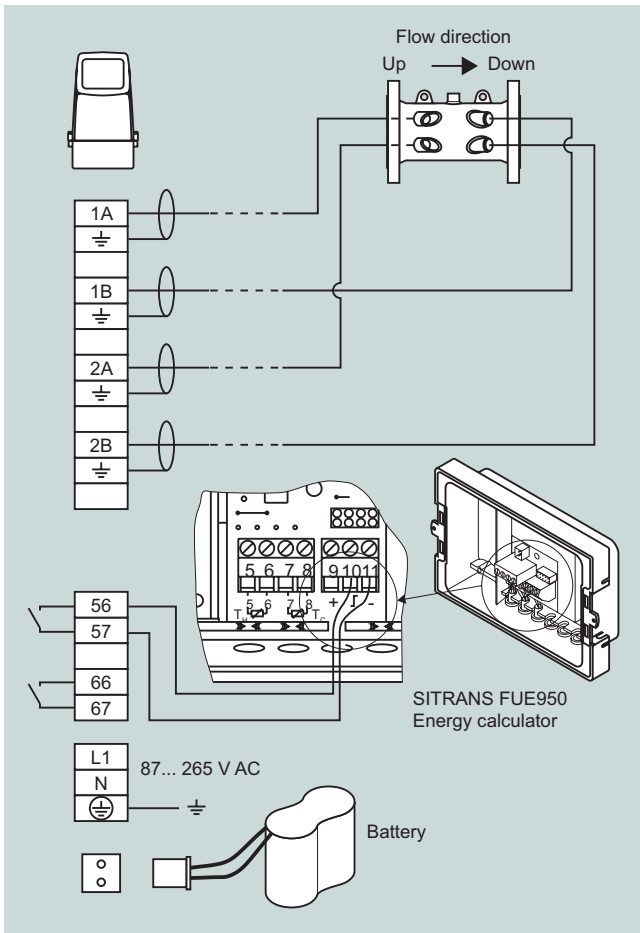

The scheme shows the transducer cable connections between transmitter terminals and respective transducer and the electrical connection of the energy calculator SITRANS FUE950.